

***Grade 11 & 12
Course Selection Guide
2024-2025***

***Mount Baker
Secondary
School***



Home of the WILD

Mount Baker Secondary School

Option 1:

Mount Baker Secondary School is the home for approximately 1,000 Grade 10 – 12 students. It is the largest high school in the district. Mount Baker prides itself in offering a large variety of courses and having strong academic programs. It is a dual track school, offering English and French Immersion classes. It is fast paced with 4 classes (semester system) per day. Regular attendance is necessary to be successful at Mount Baker.

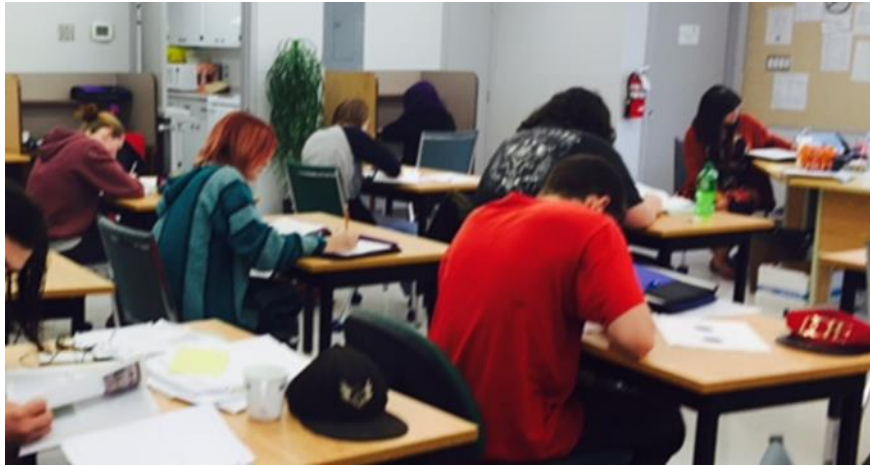

Option 2:

Kootenay Educational Services (KES) is an alternate educational setting designed to accommodate the educational, social, and emotional well-being of vulnerable or at-risk students whose needs are not being met in a traditional school environment. KES uses a paper-based, self-paced delivery model with a very high level of one-to-one academic and social/emotional support. KES students are still considered Mount Baker students for graduation, yearbook, sports teams, etc. KES students also have the opportunity to take core or elective courses at Mt. Baker. To attend KES, there is an application process for suitability, and there must be agreement and input from student, parent/guardian, school staff, and/or other relevant professionals. Talk to your counsellor or school administration to see if KES could be right for you!



Both schools require the same courses to graduate, offer the same graduation programs, and are equally recognized by Post Secondary Institutions.

GRADUATION REQUIREMENTS 2023 GRADUATION PROGRAM

The 80-credit graduation requirements table

REQUIREMENTS	POSSIBLE COURSES	CREDITS
English Language Arts 10	An approved English Language Arts 10 course	4
English Language Arts 11	An approved English Language Arts 11 course	4
English Language Arts 12	An approved English Language Arts 12 course	4
Social Studies 10	Social Studies 10	4
Social Studies 11 or 12	A Social Studies 11 OR a Social Studies 12	4
Science 10	Science 10	4
Science 11 or 12	A Science 11 OR a Science 12	4
Mathematics 10	Foundations of Math & Pre-Calculus 10, Workplace Math 10	4
Mathematics 11 or 12	Foundations of Math 11, Pre-Calculus 11, Workplace Math 11, Computer Science 11, History of Math 11, Geometry 12, Pre-Calculus 12, Calculus 12, Apprenticeship Math 12, Foundations of Math 12, Statistics 12	4
Physical & Health Education 10	Physical and Health Education 10	4
Arts Education / Applied Design, Skills and Technology	Various choices from Arts Education / Applied Design, Skills and Technology	4
Career Education Courses	Career Life Education 10, Career Life Connections 12	8
TOTAL		52 credits
ELECTIVE COURSES		28 credits
OVERALL TOTAL		80 credits
PROVINCIAL GRADUATION ASSESSMENTS		
Graduation Numeracy Assessment in Grade 10 and the Graduation Literacy Assessments in Grade 10 and Grade 12		Complete
<p>**Of the 80 credits needed for graduation, at least 16 credits MUST be at the Grade 12 level, including a Grade 12 English Language Arts course.</p> <p>**All Ministry-authorized and Board/authority-approved courses count towards the 80 credits.</p> <p>**Career Life Connections can be used to help satisfy the requirement for at least 16 credits at the Grade 12 level.</p> <p>**One 4-credit Indigenous-focused course MUST be taken by Grade 12 and can count towards the 80 credits needed for graduation.</p>		

GRAND TOTAL:

80 CREDITS

Don't forget that post-secondary institutions often require you to complete specific courses to get into certain programs. Careful planning in Grades 10, 11 and 12 will ensure you have all the courses and credits you need.

English Language Arts 11

****All English Language Arts 11 choices have a prerequisite of an English Language Arts 10****

EFP Literary Studies 11 and New Media 11 (MELNM11)

English First Peoples Literary Studies 11 is designed for students who are interested in exploring First Peoples' literature in a variety of contexts, genres, and media. The New Media component encourages students who are interested in exploring the increasing importance of digital media in communicating and exchanging ideas.

EFP Literary Studies 11 and Spoken Language 11 (MELSL11)

English First Peoples Literary Studies 11 is designed for students who are interested in exploring First Peoples' literature in a variety of contexts, genres, and media. Spoken Language 11 is designed for students who are interested in studying First Peoples' oral traditions and in developing their oral self-expressions and communication in a variety of contexts.

EFP Literary Studies 11 and Writing 11 (MEFLS11)

English First Peoples Literary Studies 11 is designed for students who are interested in exploring First Peoples' literature in a variety of contexts, genres, and media. The writing component allows students to explore a variety of genres and writing forms.

Literary Studies 11 and Composition 11 (MCMPS11)

This course allows students to delve deeply into literature as they explore themes, periods, authors, and areas of the world through literary works. Composition 11 is designed to support students as they refine, clarify, and adjust their written communication through practice and revision. Composition 11 allows students to explore a variety of genres and writing forms, both formal and creative.

Literary Studies 11 and New Media 11 (MNMD-11)

This course allows students to delve deeply into literature as they explore themes, periods, authors, and areas of the world through literary works. New Media 11 is a program of studies designed to reflect the changing role of technology in today's society and the increasing importance of digital media in communicating and exchanging ideas.

Literary Studies 11 and Spoken Language 11 (MSPLG11)

This course allows students to delve deeply into literature as they explore themes, periods, authors, and areas of the world through literary works. Spoken Language 11 is designed to support students as they refine, clarify, and adjust their spoken communication through practice and revision. Spoken Language 11 is designed to help students develop their oral self-expression and communication in a variety of contexts.



English Language Arts 12

English First Peoples 12 (MENFP12)

Prerequisite: an English Language Arts 11 or an English First Peoples Language Arts 11

With an emphasis on First Peoples' world views, this course is an academic equivalent to English Studies 12.

English Studies 12 (MENST12)

Prerequisite: an English Language Arts 11 or an English First Peoples Language Arts 11

This course attempts to enhance and mature literacy skills and knowledge with particular emphasis on prose, poetry, and composition as preparation for the Grade 12 Literacy Assessment. The novel, short story, non-fiction, and poetry are also studied in depth to expand critical assessment.

Creative Writing 11 (MCTWR11)

Prerequisite: None

Creative Writing 11 is an elective course designed for students who have an interest in, and a flair for, writing. The course allows students to extend their academic and creative writing skills beyond those available in English courses. A disciplined approach to writing, enjoyment of the written word, and a willingness to attempt writing in several different genres are necessary for success in this course.

****This course does not meet the LA 11 requirements for the 2018 Grad Program****

Creative Writing 12 (MCTWR12)

Prerequisite: None

Creative Writing 12 is an elective course designed for students who have an interest in, and a flair for, writing. The course allows students to extend their academic and creative writing skills beyond those available in English courses. A disciplined approach to writing, enjoyment of the written word, and a willingness to attempt writing in several different genres are necessary for success in this course.

****This course does not meet the LA 12 requirements for the 2018 Grad Program****



Math 11

The Mathematics Department at Mount Baker Secondary School encourages students to consider their future plans when choosing a math course and to consider taking multiple math courses to increase their options for study after high school.

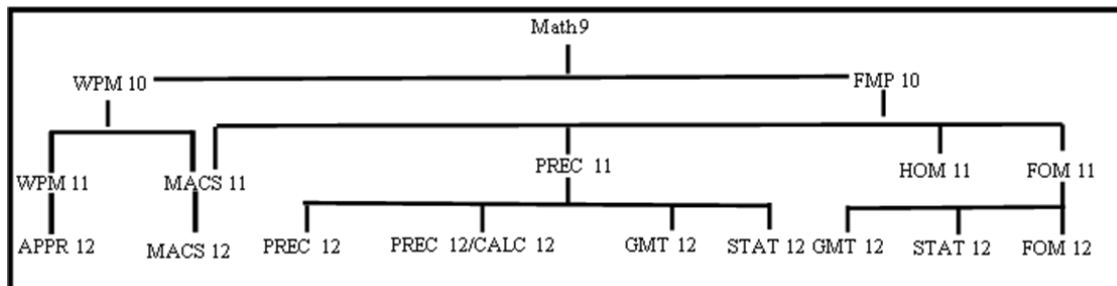

Chess 11

YouTube Link: <https://youtu.be/-jcNyq3rUNM>

Prerequisite: None

This course will focus on a brief history of chess, chess in culture, rules and etiquette, how to read and record chess games, strategy, tactics, opening, middle and endgame theory. This course will explore methods solving chess puzzles and problems. There will be a focus on daily in-class play. Students will benefit from the logical, critical, analytical, and creative thinking that chess provides – skills that can be transferred to all subject areas and facets of life. This course will be enjoyable for students of all levels and no prior knowledge of chess is required. Email mark.paron@sd5.bc.ca for more information.

Computer Science 11 (MMACS11)

Prerequisite: None

This course is for students wanting to pursue University or College Computer Studies, Engineering, Business, Data Analyst, Games Developer, and IT Consultant.

Foundations of Mathematics 11 (MFOM-11)

Prerequisite: MFMP-10

This course is for students wanting to pursue non-math/science University programs, Psychology, Sociology, Humanities, Nursing and Teaching.

History of Mathematics 11 (MHOM-11)

Prerequisite: MFMP-10

This course will study the development of math over the centuries, the evolution of number systems and various approaches to mathematics, how mathematicians' curiosity and enjoyment led to the development of many areas of mathematics. This course is suited for students seeking a Math 11 credit without pure Math content, and students interested in taking extra Math credits.

Pre-Calculus 11 (MPREC11)

Prerequisite: MFMP-10

This course is for students wanting to pursue University Sciences, Mathematics, Engineering, Medicine, most Medical Technician programs, Teaching, and the Electrical Trades.

Workplace Mathematics 11 (MWPM-11)

Prerequisite: MWPM-10

This course is for students wanting to pursue most Trades programs.

Math 12

Mathematics provides students with the opportunity to develop skills in:

- Numeracy
- Logical Thinking
- Problem Solving
- Practical Applications of Math

Apprenticeship Mathematics 12 (MAPPR12)

Prerequisite: MWPM-11

This course is for students wanting to pursue most Trades programs.

Foundations of Mathematics 12 (MFOM-12)

Prerequisite: MFOM-11

This course is for students wanting to pursue non-science University programs, Psychology, Sociology, Humanities, Nursing, and Teaching.

Geometry 12 (MGMT-12)

Prerequisite: MPREC11 or MFOM-11

This course will study geometric proofs, applications of geometry and the use of geometry throughout history. This course is suited for students considering careers in Math and Sciences, especially Engineering and Architecture.

Pre-Calculus 12 (MPREC12)

Prerequisite: MPREC11

This course is for students wanting to pursue University Mathematics, Sciences, Engineering, Medicine, most Medical Technician programs and the Electrical Trades program.

Pre-Calculus 12 and Calculus 12 (linear) (MPREC12/MCALC12)

Prerequisite: MPREC11

YouTube Link: <https://youtu.be/tvHe62eEHYg>

This course covers Pre-Calculus 12 and first-year University Calculus topics at most post-secondary institutions. This course is for students wanting to pursue University Sciences, Mathematics, Engineering, Medicine, most Medical Technician programs and the Electrical Trades.

Statistics 12 (MSTAT12)

Prerequisite: MPREC11 or MFOM-11

This course will study methods of gathering, analyzing, and representing data, and using and understanding the results of statistical analysis in society. This course is suited for students considering careers in Math and Sciences, especially Biology as well as Business, Psychology, and the Humanities.

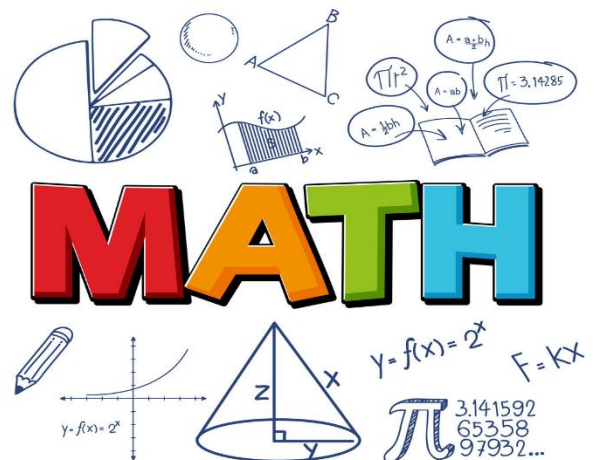

Science 11

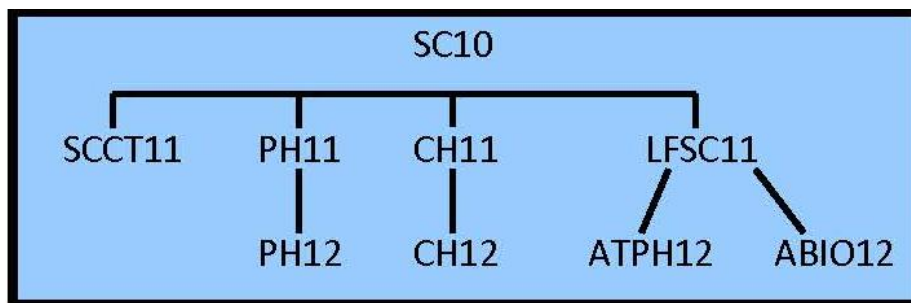

Biology 11 (Life Sciences 11) (MLFSC11)

Prerequisite: MSC10

Life Sciences is the study of life. Throughout the course you will study the evolutionary relationships that all life forms share from the simplest to the most complex. We examine cells, DNA, plants, and animals. You will use microscopes, grow bacteria, and of course perform dissections of a variety of animals to learn how life works.

Chemistry 11 (MCH11)

Prerequisite: MSC10, Recommended that the student has successfully completed MFMP10

Chemistry 11 is an academic course that is a prerequisite for Chemistry 12, and for many areas of study at post-secondary institutions. Chemistry 11 introduces the student to the many fields of chemistry, including safety, measurement, the mole, stoichiometry, the language of chemistry, the periodic table, and organic chemistry. The student will do many laboratory experiments to develop and reinforce the concepts being presented.

Physics 11 (MPH11)

Prerequisite: MFMP10 & MSC10, Recommended minimum C+ in Math 10

Physics 11 is an academic course that focuses on the principles and theories of physics. Physics is an essential course leading to academic studies and career training in the fields of science, technology, and medicine. This course introduces students to a variety of key areas in physics such as kinematics, dynamics, energy, Einstein's Special Theory of Relativity, light, and electricity. Students will do an engineering project and lab experiments to develop and reinforce the concepts being presented.

Science for Citizens 11 (MSCCT11)

Prerequisite: MSC10

This 4-credit course investigates the impact that science has on our employment, our daily lives, and our response to adapt both locally and globally to scientific processes, scientific knowledge, and how we understand science in the world. This course qualifies as a grade 11 science credit towards graduation for students not interested in mainstream Life Science 11, Chemistry 11, or Physics 11.



Science 12

Biology 12 (Anatomy and Physiology 12) (MATPH12)

Prerequisite: MLFSC11 Recommended 60%.

Life processes, cells, tissues, and body systems in humans are the main concerns of Anatomy and Physiology 12. Laboratory exercises investigate the properties of cells, enzymes, blood, and the heart, culminating in an extensive dissection and lab exam of the fetal pig. Anatomy and Physiology 12 prepares students for post-secondary programs that require a biology background.

Chemistry 12 (MCH12)

Prerequisite: MCH11

Chemistry 12 is an academic course for those students who did well in Chemistry 11 and intend to pursue further studies in chemistry or a related field. The course involves a detailed study of reaction rates and energetics, chemical equilibrium, solubility equilibrium, acids and bases, and concepts related to oxidation and reduction. The student will do many lab experiments to develop and reinforce the concepts being presented.

Physics 12 (MPH12)

Prerequisite: MPH11

Physics 12 is a rigorous course suitable for students who have a particular interest in physics or who plan to continue in science or engineering. Physics 12 is the study of classical mechanics and electromagnetism and is designed to help students develop analytical and problem-solving skills. Topics studied include two-dimensional analysis of kinematics, dynamics, momentum, equilibrium, and circular motion. Students will also be introduced to the concepts of electricity and magnetism. Strong math skills are essential.

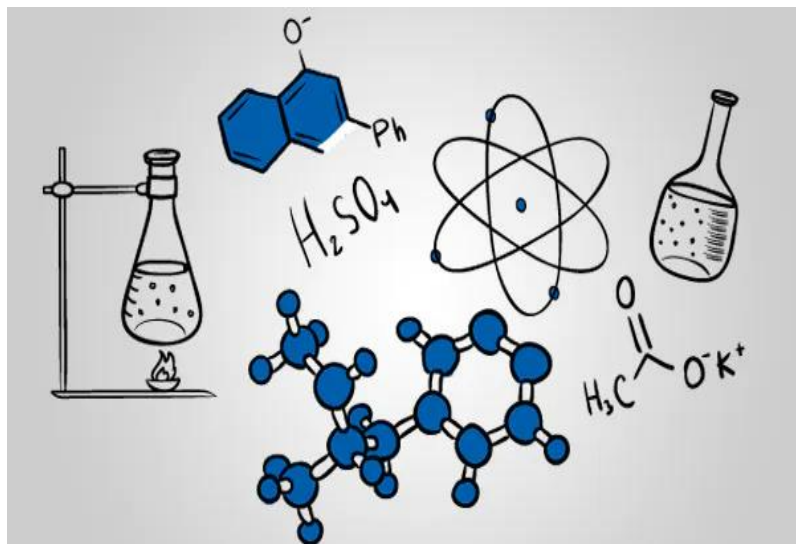

Socials

Each post-secondary institution/program will accept certain Social Studies courses for entrance requirements. Please check with the post-secondary institution or your counsellor to be sure

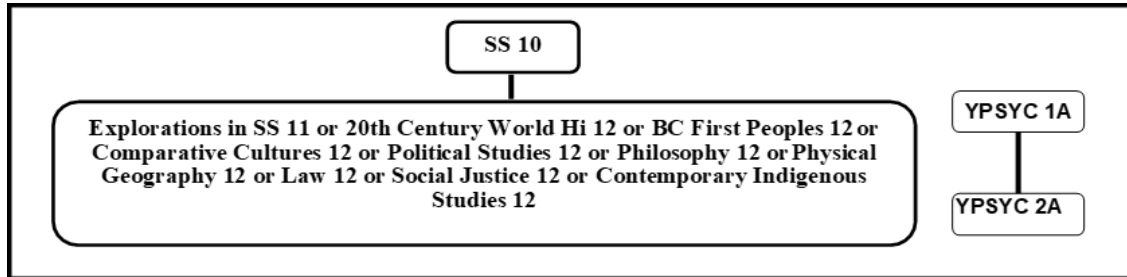

20th Century World History 12 (MWH12)

Prerequisite: MSS10

20th Century World History 12 is a survey course of world events of the 20th century. Global conflicts (WWI-Cold War), social revolutions (communism), human rights issues (South Africa, USA) and the political independence of India and the Middle East are investigated. Students will analyze and think critically about events such as the fall of imperialism, rise of nationalism, and the development of personal and national identities.

BC First Peoples 12 (MBCFP12)

Prerequisite: MSS10

BC First Peoples 12 explores history, tradition, culture, and the role of oral tradition of our First Peoples in BC. You will examine past, present and future historical changes as well as understand the political policies and practices, such as governance, the treaty process, appropriation, and protocols. This is a course that recognizes the importance of cultural diversities.

Contemporary Indigenous Studies 12 (MINST12)

Prerequisite: MSS10

This course examines factors that sustain and challenge the identities and worldview of Indigenous peoples including the importance of connections to the land. The course also explores resilience and survival of Indigenous peoples in the face of colonialism. It aims to help in understanding the reconciliation process.

Explorations in Social Studies 11 (MEPSS11)

Prerequisite: MSS10

This course will allow you to meet the graduation needs for Social Studies. It presents an overview of themes that arise in more detail in the grade 12 offerings at MBSS. It is meant to be a survey course that will cover themes such as History, Geography, Social Justice, & Social Studies topics in the modern world.

Social Justice 12 (MSJ12)

YouTube Link: <https://youtube.com/shorts/2SdZB2-z7rE>

Prerequisite: MSS10 or teacher approval

Social Justice 12 focuses on analysis of historical and contemporary issues in Canada and across the globe. We will explore the causes and consequences of events, legislation, and court decisions and how they transform individuals and societies. Community organizations, guest speakers, and resources outside of the classroom will support our ideas and discussions.

Socials

Comparative Cultures 12 (MCMCL12)

YouTube Link: <https://youtu.be/CYR9kfHXAzo>

Prerequisite: MSS10

How did we get to where we are as humans today? This course is a blend of sociology, anthropology, and the history of humanity from our earliest beginnings forward. Students will study civilizations such as Egypt, Greece, Rome, China, and Japan. They will study time periods such as the medieval age and Renaissance. They will focus on how the belief systems, geography, art, and histories of these world civilizations have impacted their culture.

Law Studies 12 (MLST12)

Prerequisite: MSS10

Law 12 is an introduction into Canadian law. Students will study criminal law, civil law, family law, the Youth Criminal Justice Act, trial procedure, and sentencing. Through in-depth analysis and written responses, students will discuss the social and legal impacts of court cases. Attending court proceedings will promote an understanding of the judicial process.

Physical Geography 12 (MPGEO12)

YouTube Link: <https://youtu.be/uv7ln3-GzKo>

Prerequisite: MSS10

Through the study of Physical Geography, you will develop an understanding of weather and climate, minerals and rocks, natural disasters, and erosional landscapes. Through this course you will be able to interpret landscapes and understand the processes shaping them. You will also study environmental issues and resource management using real world examples. A great course for those interested in careers in environmental sciences, geology, aviation, forestry, conservation, parks, adventure tourism, and engineering.

Philosophy 12 (MPHIL12)

YouTube Link: <https://youtube.com/shorts/Qo8QvT198V8>

Prerequisite: MSS10

This course is an introduction to general philosophical inquiry. The development of critical thinking, argumentative essay writing, and debating skills will be the main objectives. Through selected readings, both classical and contemporary, the student will explore the great questions that confront the thinking person:

1. What is free will?
2. Does God exist?
3. What is real? Does a tree make a sound when it falls if nobody hears it?
4. What is the nature of good and evil?
5. What is the meaning of life?

As well, current debates on social policy issues such as bioethics, euthanasia, crime and punishment, and universal welfare will be examined. A student must enjoy reading, writing, and debating to succeed in this course.

Political Studies 12 (MPLST12)

Prerequisite: MSS10

This course focusses on the political world and how you as an informed citizen can influence and make changes. We will focus on Canadian politics and international democratic systems and how political agreements are a compromise of values and traditions.

Socials - Psychology

Psychology 11 (YPSYC1A)

YouTube Link: <https://youtu.be/tQCmx2kT014>

Prerequisite: Must be in Grade 11 or 12

Psychology 11 has been designed to focus on areas of interest for students who want to examine and understand human behavior (their own and others). An interesting, fast-paced elective, this course requires a strong work ethic for success. Topics covered include research techniques, the nature/nurture debate, depression, sleep, motivation, human development, and social psychology. Assignments entail individual and group projects, small group presentations and major projects. Although this is an elective class, this is an academic course and students will be more successful once they have passed Science 10 and English 10.

Psychology 12 (YPSYC2A)

YouTube Link: <https://youtu.be/tQCmx2kT014>

Prerequisite: YPSYC1A

Psychology 12 builds on topics from Psychology 11. Students will be required to examine, in depth, major themes in the field of psychology. Students will use textbooks, technology and required readings to examine the following topics: critical thinking, intelligence, personality, psychological disorders, sensation, and perception. Assignments entail individual and group projects, oral presentations, and major projects.

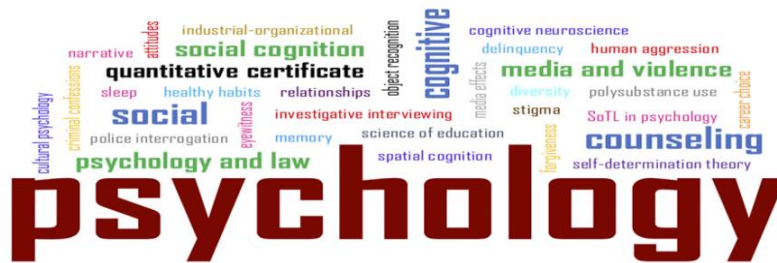

Career Life Connections 12

OPTION 1:

Career Life Connections 12A will be offered outside the timetable to Grade 11 students. While working closely with our platform called “My Blueprint”, students will be expected to complete the required course material with teacher supervision and support. This is 2 of the 4 credits for the CLC 12 Graduation requirement.

Career Life Connections 12B (Capstone) will be offered outside the timetable for students who have successfully completed Career Life Connections 12A by the end of their Grade 11 year. Students will meet with a supervising teacher who will support and guide them in preparing their required Capstone presentation. Career Life Connections & Career Life Connections Capstone will be offered to those students who had to repeat Career Life Education or were unsuccessful in completing Career Life Connections in Grade 11. They will have a block assigned inside the timetable to meet the course expectations. This combination would also be available for students who prefer it and have the flexibility to forego another elective course.

OPTION 2:

Career Life Connections 12 A & B (MCLC12): this in-timetable course focuses on applying career-life management knowledge, skills, and strategies to the student’s own personal life journey and planning for post-graduation. Personal career-life development includes competencies of the educated citizen, reflection strategies, mentorship opportunities, factors that shape identity and career-life choices, personal strategies to sustain well-being, and awareness of rights and regulations in the workplace. Capstone – each grade 12 student will present to a teacher and perhaps another community individual a final capstone which is prepared during CLC. The Capstone will reflect on the learning journey in and out of school.

Advanced Placement

What are Advanced Placement courses? These courses allow students to take university/college level courses and exams, and potentially earn university/college credit or placement, while still in high school. Each AP course has an exam, administered worldwide in May. Each exam consists of multiple-choice questions and a free response section. The exam is scored on a five-point scale: 5 - extremely well qualified, 4 - well qualified, 3 - qualified, 2 - possibly qualified, & 1 - no recommendation. **Students are responsible for the cost of the exam. (Approx. \$100 US)** University credit will vary depending on your choice of post secondary education.

What are the benefits?

Besides the potential of earning university/college credits while still in high school, there are added benefits to taking Advanced Placement courses. Students learn to challenge themselves, foster critical thinking and inquiry-based lab skill, and develop advanced study habits, while saving money on university/college tuition.

Are Advanced Placement courses right for you?

If you are a highly motivated and curious student with a good grade point average, strong reading and writing skills, and are pursuing post secondary education at a university or college, Advanced Placement courses would be a great fit for your Grade 12 course selections.

Advanced Placement Biology 12 (Anatomy & Physiology 12) (ABIO12)

Prerequisite: MLFSC 11

This eight-credit course focuses on the anatomy & physiology of body systems, along with the four big ideas from the internationally recognized AP Biology course. Using curricular AP science practices, students will explore how the process of evolution drives the diversity and unity of life; how biological systems use energy & molecular building blocks to grow, reproduce, & maintain dynamic homeostasis; how living systems store, retrieve, transmit, and respond to information essential to life processes, & how biological systems interact & exhibit complex properties. In addition to the extensive dissection of the fetal pig, students will design and perform inquiry-based biology experiments as they collect, analyze, and interpret data to draw conclusions and compare their findings to peer reviewed scholarly researched papers. Students will have the opportunity to work with precision biological equipment such as wave-length molecular spectrophotometers, micropipettes, DNA fingerprinting, and more. Students will be given access to the AP Classroom app to review and access their progress throughout the course. For more information about this course, please email Catherine.Fillis@sd5.bc.ca.

Advanced Placement English Language and Composition (AEN12)

Prerequisite: An English Language Arts 11

This survey course, geared towards students who will attend post-secondary, teaches the elements of argument and composition, developing critical reading and writing skills. Texts will include non-fiction works from various periods and students will write essays with different aims; for example, to explain an idea, argue a point or persuade the reader of something. Learned skills will include reading closely, analyzing and interpreting text in addition to evaluating a source of information. Drafting and revising writing that includes evidence-based arguments will also be a focus. Students will have the option of writing the Advanced Placement exam in May which may allow students to receive university credit for an introductory literary analysis course if the exam score is high enough to meet the standard.

****This course does not meet the English Language Arts 12 requirements for the 2023 Grad Program.**

French Immersion

Students must complete six courses in the French Immersion Program to be eligible for a dual Dogwood Graduation Diploma

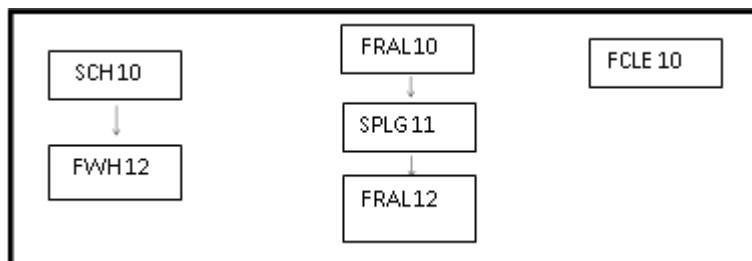

French Immersion YouTube Link: <https://youtu.be/nNsvbvUusk>

Communication Orale 11 (FSPLG11)

Prerequisite: FRAL 10

This course reviews more advanced French grammar and verbs, in conjunction with direct & indirect object pronouns. A variety of non-fiction writing styles is examined: newspaper articles, persuasive essays, and advertisements. Novel studies focus on comprehension and explore how literary and artistic works reflect Francophone culture and history. Since the focus is on oral communication, students are required to prepare a variety of oral presentations such as speeches, plays, videos, audio recordings, interviews, and debates.

Français Langue Seconde- Immersion 12 (FRAL12)

Prerequisite: FSPLG11

This course continues an advanced study French grammar and verbs, exploring literary tenses such as the subjunctive and the past historic, along with complex sentence structure. Novel and poetry studies shift from merely comprehending to inferring - recognizing and understanding symbols and analogies in French.

Students are expected to incorporate the cumulative knowledge and skills acquired throughout grades 10, 11 and 12 into the preparation of many forms of oral and written projects.

Histoire du monde au XXe siècle 12 (FWH12)

Prerequisite: FSCH10

20th Century World History 12 is a survey course of world events of the 20th century. Global conflicts (WWI- Cold War), social revolutions (communism), human rights issues (South Africa, USA) and the political independence of India and the Middle East are investigated. Students will analyze and think critically about events such as the fall of imperialism, the rise of nationalism, and the development of personal and national identities.

****French is the only language spoken in the classroom****



Physical and Health Education

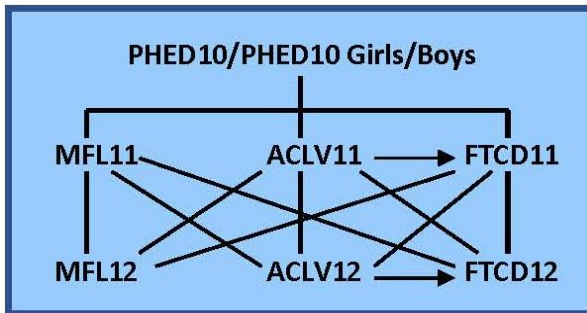

Why it makes sense to take a P.E. course:

- Take a stress free break from your heavy academic schedule.
- Develop a high level of fitness in preparation for physically demanding careers such as firefighting, law enforcement, Canadian Forces, forestry technology, etc.
- Explore the fast growing careers of Physical Education, Adventure Recreation, Sports Management, Coaching, Personal Fitness Trainer.
- Focus on career choices and develop skills required in specific areas of study and work.
- Fulfills the requirement for DPA.

Physical and Health Education YouTube Link: <https://youtu.be/hEPRjAvikk8>

Active Living 11 (MACLV11)

Prerequisite: MPHE10

This popular course provides students with a new experience in Physical Education. Students and teacher work together to design a program that includes a wide range of activities and a high level of participation. Students can expect to achieve personal goals in fitness development, improve leadership skills, expand their knowledge of individual and team sports, be challenged, and have fun. Students must have suitable clothing for all activities. Students may be required to contribute to travel and community activity expenses.

Active Living 12 (MACLV12)

Prerequisite: MACLV11 or MFTCD11

Students in this course will be exposed to many leisure activities with lifelong values. Activities include design and execution of fitness programs, variations of outdoor sports (soccer, football, softball, rugby, golf, skiing, cycling, jogging, tennis, field lacrosse) and indoor sports (curling, bowling, broomball, volleyball, swimming, basketball).

Fitness and Conditioning 11 (MFTCD11)

Prerequisite: MPHE10

This course is designed to give students the opportunity to learn fitness concepts and conditioning techniques used for obtaining optimal physical fitness. Students will benefit from comprehensive weight training and cardiorespiratory endurance activities. Students will learn the fundamentals of strength training, aerobic training, high intensity interval training, and overall fitness training and conditioning. Students will be empowered to make wise choices, meet challenges, and develop positive behaviours in fitness, wellness, and movement activity for a lifetime. Students will develop individual goals based on what they would like to improve upon. Some of the topics covered include nutrition, weight training, strength training, endurance training, sport specific training, circuit training, and speed and agility training. This course is suitable for a wide range of students; from those new to fitness and conditioning, to those with considerable experience. Students enrolled in this course must attend regularly due to the performance-based nature of this course.

Fitness and Conditioning 12 (MFTCD12)

Prerequisite: MFTCD11 or MACLV11/12

This course is designed to give students the opportunity to learn fitness concepts and conditioning techniques used for obtaining optimal physical fitness. Students will benefit from comprehensive weight training and cardiorespiratory endurance activities. Students will learn the fundamentals of strength training, aerobic training, high intensity interval training, and overall fitness training and conditioning. Students will be empowered to make wise choices, meet challenges, and develop positive behaviours in fitness, wellness, and movement activity for a lifetime. Students will develop individual goals based on what they would like to improve upon. Some of the topics covered include nutrition, weight training, strength training, endurance training, sport specific training, circuit training, and speed and agility training. This course is suitable for a wide range of students; from those new to fitness and conditioning, to those with considerable experience. Students enrolled in this course must attend regularly due to the performance-based nature of this course.

Arts Education / Applied Design, Skills, & Technology

****Students require 4 credits of Arts Education OR 4 credits of Applied Design, Skills & Technology****

Ministry Authorized 4 Credit Arts Education Courses

MUSIC

Choral Music: Concert Choir 10, 11, 12
Choral Music: Vocal Jazz 11, 12
Composition and Production 11, 12
Instrumental Music: Concert Band 10, 11, 12
Instrumental Music: Guitar 11, 12
Instrumental Music: Jazz Band 10, 11, 12

THEATRE

Dance Foundations 11 (BA)
Drama 10, 11, 12
Film and Television 11, 12
Musical Theatre 10, 11, 12
Theatre Company 10, 11, 12
Theatre Production 10, 11, 12

ART, GRAPHICS, AND LIFE SKILLS

Art Studio 10, 11, 12
Media Arts 11, 12
Photography 11, 12
Studio Arts 3D 12
Yearbook 11 (BA)
Yoga and Mindfulness 12 (BA)

Ministry Authorized 4 Credit Applied Design, Skills & Technology Courses

COMPUTER STUDIES

Computer Information Systems 11, 12
Computer Programming 11, 12

HOME ECONOMICS

Child Development/Caregiving 12
Food Studies 11, 12

TECHNOLOGY EDUCATION

Art Metal & Jewellery 12
Drafting 11, 12
Electronics 11, 12
Industrial Coding & Design 12
Metalwork 11, 12
Robotics 11, 12
Train: Train in Trades 12
Woodwork 11, 12
Woodwork - Furniture and Cabinetry 12
Work Experience 12
Youth Work in Trades 11, 12

BUSINESS EDUCATION

Accounting 11, 12
Business Computer Applications 12
Entrepreneurship 12
Marketing & Promotion 11

Arts Education / Applied Design, Skills, & Technology

MUSIC

Mount Baker provides a well established, dynamic, and rigorous music program. Courses are offered in Concert Band, Jazz Band, Instrumental Music, Concert Choir, Vocal Jazz, and Composition and Production. Several courses are offered outside of the regular timetable. Attendance at all rehearsals and performances is mandatory. The expected home practice time for each course ranges from 1.5 to 3 hours a week. Not all courses require previous music experience.

Music Courses YouTube Link: <https://youtu.be/3fDqQ4gGQuY>

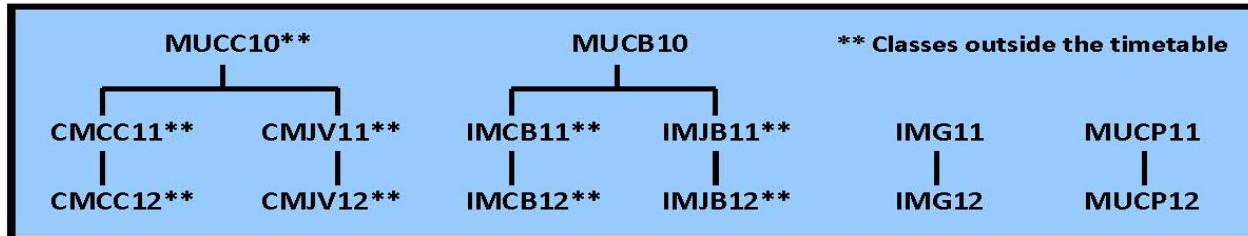

Choral Music 11: Concert Choir (MCMCC11) **

Prerequisite: None, Course Length: All Year (Wednesdays—3:30-5:00 pm)

Concert Choir is a course that provides voice instruction and choral ensemble skills to all students, regardless of previous musical experience. Grade 10, 11, and 12 students form the Mount Baker Concert Choir.

Elements of the course include:

1. Vocal technique and tone production.
2. Posture, breathing and range development.
3. Ear training, harmony singing and sight singing.
4. Ensemble and solo skill building.
5. Performance of various styles and genres of vocal repertoire.
6. Studio and live recording sessions.

Choral Music 12: Concert Choir (MCMCC12) **

Prerequisite: none, Course Length: All year, Wednesdays, 3:30 - 5:00 PM

Concert Choir 12 provides a greater degree of focus for the vocal student, with an added element of leadership roles and mentorship within the ensemble. Students in Concert Choir 11 and 12 will be able to assist in planning the logistics and management of performances and productions and supervise stage crew and show running. Students must be enrolled in Concert Choir to be permitted to audition for Vocal Jazz.

Choral Music 11/12 Vocal Jazz (MCMVJ11), (MCMVJ12)

Prerequisite: Concert Choir 10, Concert Choir 11, Vocal Jazz 11. By audition only.

Vocal Jazz 11/12 is designed for serious vocal students interested in studying more challenging repertoire in the rock, jazz, funk, swing, & pop styles. Music reading ability is recommended. Lessons will be directed more toward microphone technique, tone production, & ear training. Students will work with theory, arranging, & chord reading. The course also offers credit for instrumental musicians. Places for piano, electric guitar, bass, & drums will be available for audition. Students taking Vocal Jazz must also be enrolled in Concert Choir.

Instrumental Music 11: Concert Band (MIMCB11), 12 (MIMCB12) **

Prerequisite: MMUCB10 or permission of music director. All Year (Mon & Fri, 3:30-5:00 pm)

This course is a combined class of Grade 11/12 Concert Band & forms the Mount Baker Senior Concert Band. This course further develops the progression from Concert Band 10 at an advanced level. There will be a focus on solo work, small ensemble playing, & a greater quantity & quality of public performance & recording work. Students will also be given the opportunity to perform in community & school district roles & participate in theatre productions as orchestra pit players. Students in Concert Band 11 & 12 will be able to assist in planning the logistics & management of performances & productions & supervise stage crew & show running. Concert Band 12 students will have a focus on leadership roles & work as mentors in the program. Students must be enrolled in Concert Band to be permitted to audition for Jazz Band courses.

Arts Education / Applied Design, Skills, & Technology

MUSIC

Instrumental Music: Guitar 11 (MIMG11), Guitar 12 (MIMG12)

Prerequisite: None, Course Length: Semester

Guitar 11 and 12 are introductory level guitar courses. They offer interested students the opportunity to learn and practice the skills and techniques involved in playing songs they love. Chord playing (open and arpeggiated), single note playing, picking, fingering, strumming, and hand positions are covered. Single line melody reading, tablature, note articulation techniques, barre chording, music scales, and playing techniques are also introduced.

Instrumental Music 11: Jazz Band (MIMJB11) **

Prerequisite: MMUCB10. Admitted by audition only. All year (Tues & Thurs @ 7:30 am)

This course offers the student the opportunity to study challenging music in the jazz, funk, Latin, and rock genres. Students will work with theory, chord reading, and arranging original material. There is a significant emphasis on sectional work, improvisation, and soloing. This class combines with Grade 12 Jazz Band students to form the Mount Baker Jazz Band. Students taking Jazz Band must also be enrolled in Concert Band.

Instrumental Music 12: Jazz Band (MIMJB12) **

Prerequisite: MIMJB11, Admitted by audition only. All year (Tues & Thurs @ 7:30 am)

Jazz 12 is similar to Jazz 11, only with more emphasis on soloing and advanced study of technique and theory. Opportunities will be made available to individual students to compose, arrange, and direct original material. The members of this class combine with Grade 11 Jazz Band students to form the Mount Baker Jazz Band. Students taking Jazz Band must also be enrolled in Concert Band.

Music Composition and Production 11 (MMUCP11)

Prerequisite: Basic notation or chord reading ability, basic instrumental playing skills

Students will learn the basics of creating their own original music using the latest in digital audio technology including the Reason software platform. Lessons include basic music theory, form, & harmony in a wide variety of musical genres. Students will also receive hands on training in live & studio recording techniques. Learning is based on solo & team-based projects, with each student producing one original composition that will be released on a class compilation album under the program's own label, Orange Door Studios. Basic note & chord reading skills as well as the ability to play an instrument is highly recommended. Headphones are required equipment for each student.

Music Composition and Production 12 (MMUCP12)

Prerequisite: MMUCP11 or audition by instructor

MUCP12 is similar to MUCP11 but with an emphasis on production, live audio recording, mixing, and engineering. Students will be expected to draw on their training from MUCP 11 to compile a final portfolio consisting of 5 to 7 original compositions. Students will not be permitted to take this advanced level without first having earned the prerequisite course or demonstrated an appropriate level of competency. Each student's final album will be individually copywritten through the Orange Door Studio label and released on all major music streaming platforms and services. A single from each album will be part of the class compilation album. A focus on career development will provide students with opportunities to work with other musicians and artists by assisting in live PA performance work and recording of concerts and events. The course will culminate in a live performance event, open to the public. Headphones are required equipment for each student.



Arts Education / Applied Design, Skills, & Technology

ART, GRAPHICS, AND LIFE SKILLS

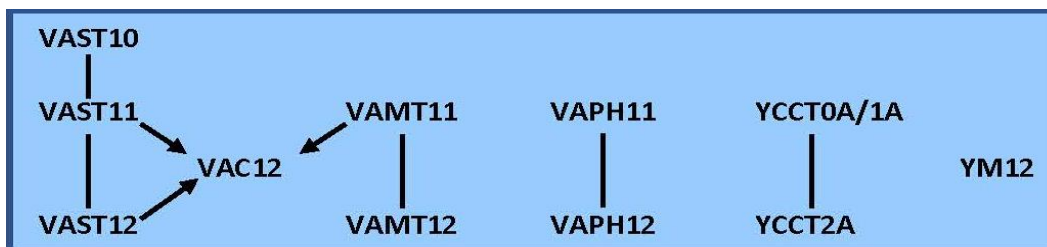

Art Studio 11 (MVA11)

Prerequisite: None – Recommended MVA10

This is a comprehensive course designed to facilitate a broad range of experiences in 2-D and 3-D visual arts. Students will build upon previous learning in Visual Arts 10 by creating and responding to a variety of 2-D and 3-D images. It includes both traditional and contemporary 2-D and 3-D media, such as drawing, painting, ceramics, sculpture, printmaking, and design.

Art Studio 12 (MVA12)

Prerequisite: MVA11

This comprehensive course is designed to facilitate students who desire a general yet broad range of experiences in 2-D and 3-D visual arts. Students will build upon previous learning in Art Foundations 11. It includes both traditional and contemporary 2-D and 3-D media, drawing, painting, ceramics, sculpture, print making and design.

Media Arts 11 (MVA11), Media Arts 12 (MVA12)

Prerequisite: MVA11 for MVA12

YouTube Link: <https://youtu.be/r4dd7-qa9tA>

These art education courses will provide students with opportunities to develop the knowledge, skills, and attitudes needed to respond to media artworks and create art using media arts technology. These courses include silk screening, computer technologies, digital imaging, and animation as well as traditional art.

Photography 11 (MVA11)

YouTube Link: <https://youtu.be/UfKsIPFIZvA>

Prerequisite: None

Students will examine the art of Photography. Through a variety of activities and assignments, students will develop an understanding of creativity, and traditional and digital photography. They will learn how to use 35 mm and digital cameras, develop negatives and photographs, download, and manipulate images and create a portfolio presentation. Students will be using their own cell phones, but cameras can be provided upon request. Previous art experience is an asset.

Photography 12 (MVA12)

YouTube Link: <https://youtu.be/UfKsIPFIZvA>

Prerequisite: MVA11

Students will learn to understand photography as an art form, develop a deeper understanding of camera controls, traditional photography, and digital imaging. Students will use advanced techniques to create different effects using 35 mm and digital cameras, while they develop a portfolio of their images. Cameras will be provided, but students may be allowed to use their own. Previous art experience is an asset.



Arts Education / Applied Design, Skills, & Technology

ART, GRAPHICS, AND LIFE SKILLS

Studio Arts 3D 12 (MVAC12)

Prerequisite: MVA11 or 12 or MVAM11

This is a comprehensive study of artistic expression through three-dimensional work. Students will be exposed to a variety of mediums and construction methods. An in-depth study of sculptural artists and styles will be explored throughout the course. The course is intended for students who have taken visual arts and want to expand their repertoire and skills. They will be encouraged to take creative risks and express their thoughts, opinions and emotions through art. Students are given the opportunity to present and critique their work and the work of others. A great course for students considering art post-secondary or students who enjoy the 3D format.

Yearbook 10 BA (YCCT-0A), 11 BA (YCCT-1A), 12 BA (YCCT-2A)

Prerequisite: YCCT-1A for YCCT-2A

YouTube Link: <https://youtu.be/i6T3R7K4Cqs>

This course will introduce students to the world of book creation and publishing. The primary goal of this class is to produce the school yearbook. **The course is a year-long program that runs outside the timetable during lunch or after school depending on student needs.** Page building online from home may be possible. Students must be able to work independently and meet deadlines. Depending on registration numbers, students may be required to be photographers, writers, and layout artists. Extra support for students working outside their comfort level will be provided through peer mentoring and/or teacher assistance. Areas covered in Yearbook include theme selection and incorporation; development and application of good design; colour purpose, selection and usage; photography skill development and editing practices; people skills and team development; and publication program navigation and usage. Besides the yearbook production, Yearbook 12 offers interested students increased responsibility, mentoring opportunities and the Editor's position. Cameras will be provided, but students may be allowed to use their own. Previous art or photography experience is an asset.

Yoga and Mindfulness 12 BA

Prerequisite: None ****outside the timetable****

YouTube Link: <https://youtube.com/shorts/qGSyJAUooC0>

Yoga and Mindfulness 12 is designed to provide students with the tools necessary to develop a healthier and happier lifestyle. Experience various styles of yoga in a safe, supportive, non-competitive environment while improving muscle tone, strength, flexibility, balance, concentration and breathing techniques. While focusing on the physical benefits of yoga, students will explore the mental benefits of yoga. Through a supportive regular yoga practice, students will recognize how a body reacts to stress and how to manage the demands of stress – which will assist students in making responsible personal choices and decisions. This course is open to any body in any condition – male or female.

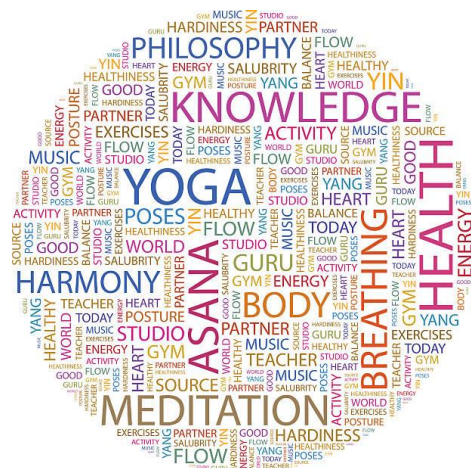

Arts Education / Applied Design, Skills, & Technology

THEATRE

Through participation in the rehearsal and performance process, students gain confidence and a sense of commitment. Theatre and film courses equip students for further study in stage performance, technical theatre, and film production, but also teach skills that are highly sought in today's business markets, such as teamwork, communication, and leadership. Classroom courses focus on skill building and company courses focus on public performance.

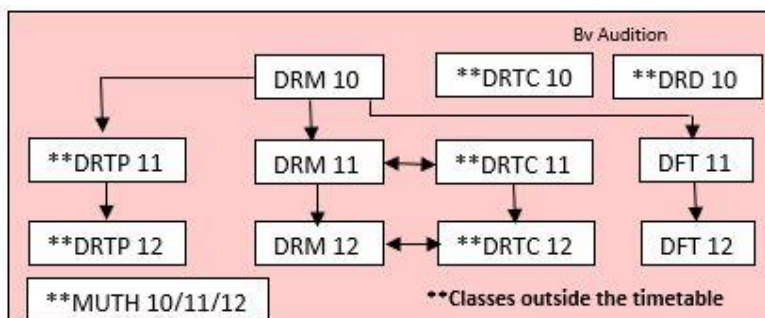

Dance Foundations 11

Prerequisite: None

This class explores dance techniques and choreography in a variety of genres. No previous dance experience is necessary. Depending on the level of interest, this class is offered both in the timetable and outside the timetable (after school).

Drama 11(MDRM11)

Prerequisite: Must be in grade 11 or 12

YouTube Link: <https://youtu.be/kLEqKNSjLOk>

Drama 11 includes improvisational skill development, knowledge of theatre related careers, acting from scripts and confidence building activities. Students will perform for an audience and learn basic tech support for productions. Presentation and communication skills learned are applicable to any profession.

Drama 12 (MDRM12)

Prerequisite: MDRM11

YouTube Link: <https://youtu.be/kLEqKNSjLOk>

Drama 12 is a text heavy course which builds upon skills covered in Drama 11. Students perform scenes from plays as well as go further in depth with role playing, characterization and a fun look at theatre history from ancient Greek ceremonies to contemporary theatre.

Film and Television 11 (MDFT11)

Prerequisite: Must be in grade 11 or 12

YouTube Link: <https://youtu.be/gSUIIN057RU0>

Film and Television 11 is an introductory course in which students will become comfortable with all aspects of digital filmmaking including acting, directing, sound production, camera work and script writing. At the end of the course, students will be expected to produce a short narrative film.

Film and Television 12 (MDFT12)

Prerequisite: MDFT11

YouTube Link: <https://youtu.be/gSUIIN057RU0>

Building on skills learned in Film and Television 11, students will increase knowledge of camera use, sound production, acting and directing and specialize in a desired genre or form of filmmaking or television production.

Arts Education / Applied Design, Skills, & Technology

THEATRE

Musical Theatre 10/11/12 (MMUTH10/MMUTH11/MMUTH12)**

Prerequisite: Audition **Outside the timetable **YouTube Link:** <https://youtu.be/fgomGLgQXGA>

Rehearse and perform in a main stage musical for Mount Baker Wild Theatre. At the Grade 12 level, leadership and mentorship of younger company members is expected.

Theatre Company 11 (MDRTC11)**

YouTube Link: <https://youtu.be/FLEf9vQLq5g>

Prerequisite: Audition **Outside the timetable

Rehearse and perform in a main stage play for Mount Baker Wild Theatre.

Theatre Company 12 (MDRTC12)**

Prerequisite: Audition **Outside the timetable

YouTube Link: <https://youtu.be/FLEf9vQLq5g>

Rehearse and perform in a main stage play for Mount Baker Wild Theatre. At the Grade 12 level, leadership and mentorship of younger company members is expected.

Theatre Production 11 (MDRTP11)**

YouTube Link: <https://youtu.be/GS8l2Slla6g>

Prerequisite: None **Outside the timetable

Theatre Production 11 is an overview of all elements related to live theatre productions. It is hands-on work in lighting, sound, props, costumes, advertising, tool safety, make-up, production design and painting techniques. Students get first-hand practical experience working on stage productions.

Theatre Production 12 (MDRTP12)**

YouTube Link: <https://youtu.be/GS8l2Slla6g>

Prerequisite: MDRTP11 **Outside the timetable

This course is designed for students with an awareness of safe tool handling and some artistic ability. Completing Theatre Production 11 is encouraged for entry to this course. We meet in the evenings twice per week to build the sets and work on all staging elements for our major productions. The course runs year long and culminates with the spring show. Students work back-stage and help design the sets, lighting, make-up, costumes, advertising, and props for productions.



Arts Education / Applied Design, Skills, & Technology

COMPUTER STUDIES

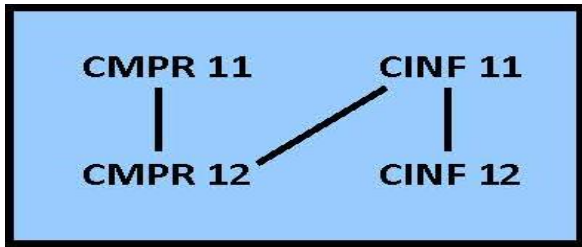

Computer Information Systems 11 (MCINF11)

Prerequisite: None

This program is designed for students interested in a career in the fast-growing area of computer servicing and support. This course may be of interest to students who just want to know more about how to fix or upgrade their own computers. It will provide a good background and allow students to become comfortable working with computers. Students will learn to upgrade, service, maintain and install computer hardware/software. Through hands-on experience, they will learn the basics of computer operating systems and network operating systems and methods for troubleshooting and resolving common computer hardware/software conflicts.

Computer Information Systems 12 (MCINF12)

Prerequisite: MCINF11

This course builds on what students have learned in ICTS11 and focuses on more advanced techniques in computer hardware/software and communications technology. Through hands-on experience, students will gain advanced knowledge of troubleshooting and resolving computer hardware/software problems.

Areas of study include:

- Computer network design and maintenance
- Network operating systems
- Computer protocols and routing
- Computer imaging

Computer Programming 11 (MCMPR11)

Prerequisite: None

YouTube Link: https://youtu.be/9l_9Yxa--nY

This course introduces students to the art of computer programming. No previous knowledge of programming is required. Students will learn how to decipher, write, and modify computer code, using Python 3. Students will learn how to identify opportunities for creating a computer program. They will be introduced to the design cycle, which includes brainstorming, breaking a problem down, and writing programs that should solve the problem. Students will learn to test and refine their program and be introduced to a variety of programming structures to help streamline and optimize their code.

Computer Programming 12 (MCMPR12)

Prerequisite: MCMPR11

YouTube Link: https://youtu.be/9l_9Yxa--nY

This course builds on the knowledge and skills introduced in Computer Programming 11. Students will conduct user-centered research to understand design opportunities and barriers. They will learn advanced programming structures. Projects will require students to use the design cycle as well as management processes when working individually or collaboratively.



Arts Education / Applied Design, Skills, & Technology

TECHNOLOGY EDUCATION

Art Metal and Jewellery 12 (MTAMJ12)

YouTube Link: <https://youtu.be/l0oiy18aO-4>

Prerequisite: None

This is an introductory course open to students from grades 10 to 12 who love the idea of designing and creating jewellery and artistic metalwork. Students will learn the safe use of metalworking hand and power tools, and techniques such as etching, soldering, welding, brazing, forging, and casting.

Drafting 11 (MTDRF11)

Drafting YouTube Link: <https://youtu.be/5iQqtrHZXo8>

Prerequisite: None

This course teaches the fundamentals of technical drawing and product design used by Architects and Engineers. The course covers the latest AutoCAD software and sketching/ board skills.

Drafting 12 (MTDRF12)

Drafting YouTube Link: <https://youtu.be/5iQqtrHZXo8>

Prerequisite: MTDRF11

This course builds on the skills learned in Drafting 11. Students spend time learning advanced drafting/design techniques used by Architects and Engineers in technical drawings. The majority of work is done using Autodesk software including AutoCAD, Inventor and Revit, with some sketching/ design skills required. This is a Design - Draw - Build course!

Electronics 11 (MTELE11)

YouTube Link: <https://youtu.be/ha-WWkwWQ0I>

Prerequisite: None

This is a foundation course which teaches students the basics of electricity and electronics. Using a hands-on approach, students explore the use of common electronic components, develop skills in the design and production of printed circuit boards and learn how to calculate and measure voltage, current and resistance in DC circuits.

Electronics 12 (MTELE12)

YouTube Link: <https://youtu.be/ha-WWkwWQ0I>

Prerequisite: MTELE11

This course builds upon Electronics 11 with more complex circuitry and projects. It involves advanced analog and digital systems as well as basic micro-controllers and an introduction to robotics. In addition, there is a unit on house wiring where students will learn to wire common circuits used in modern homes. The knowledge and skills gained could lead to a challenging career or serve as a basis for a lifelong hobby.



Arts Education / Applied Design, Skills, & Technology

TECHNOLOGY EDUCATION

Industrial Coding and Design 12 (MTICD12)

Prerequisite: Teacher recommendation

Industrial Coding and Design 12 builds on basic concepts developed in Drafting 11 and 12. Students who enjoy independent learning, creative designing and problem solving will be attracted to this option. Students will expand their 3D architectural and mechanical modelling and animation skills using industry-standard software. Students will also learn different processes for converting 3D model files into code for machine processing and will realize their designs using CNC and 3D printers. Activities in this area would effectively support a portfolio application for entrance into post-secondary.

Metalwork 11 (MTMET11)

YouTube link: <https://youtu.be/nAQXjmj6coo>

Prerequisite: None

This class uses hand and power tools that are required for working with metal. Safety and productivity are stressed throughout the program. The students will learn layout, cutting, drilling, grinding, welding, sheet metal, milling, lathe work, and forging. Students will complete several projects as a class and then have time to complete projects of their own choice. Projects include sport/ hobby/automotive accessories, small furniture items and tools.

Metalwork 12 (MTMET12)

YouTube link: <https://youtu.be/nAQXjmj6coo>

Prerequisite: MTMET11

This course builds on the skills learned in MMFM 11. This course teaches advanced hand and power tool use required for working with metal. Safety and productivity are stressed throughout the program. Students will learn about a variety of areas in metalworking. These include layout, designing, estimating, cutting, drilling, grinding, welding, sheet metal, lathe work, milling, forging, casting, and shop maintenance. Students must complete several class projects of their design and construction. Projects include sport/hobby/automotive accessories/small furniture items and tools.

Robotics 11 (MTROB11)

YouTube Link: <https://youtu.be/ha-WWkwWQ0I>

Prerequisite: None

This course uses the Lego Mindstorms system to teach students to design and build a variety of task specific robots. Students will learn how to build remotely controlled and autonomous wheeled, tracked, and multi- legged mobile robots and to program them to interface with different electronic sensors and motors. The lectures will focus on motors, sensors, and control.



Arts Education / Applied Design, Skills, & Technology

TECHNOLOGY EDUCATION

Robotics 12 (MTROB12)

Prerequisite: MTROB11

YouTube Link: <https://youtu.be/ha-WWkwWQ0I>

This course builds on the skills and knowledge gained in Robotics 11 and enables students to build more complex robotics systems. Because students will be expected to work somewhat independently, a certain degree of self-direction is necessary for success in this course.

Woodwork 11 (MWWK11) – (Level 1)

Prerequisite: None

YouTube Link: <https://youtu.be/tJUVHeGelek>

Designed for Grade 10, 11, and 12 students, this course offers skills for those who may or may not have woodworking experience. Students will learn the safe use of all machines, to read and develop plans, as well as build modern and traditional furniture. Building your skills and confidence during this course will help you with more advanced woodworking classes.

Woodwork 12 (MWWK12) – (Level 2)

Prerequisite: Woodwork 11 (Level 1)

YouTube Link: <https://youtu.be/tJUVHeGelek>

This course offers skills that build on the skills and knowledge that students have learned in Woodwork 11 and prepares students for the Furniture and Cabinetry 12 (Level 3) course.

Woodwork - Furniture and Cabinetry 12 (MTFAC12) – (Level 3)

Prerequisite: MWWK11

In this class students will learn advanced joinery and modern cabinet methods. A great class for those who want to build their own projects. Students have the opportunity to use all the specialty tools one last time before graduation to make something great!

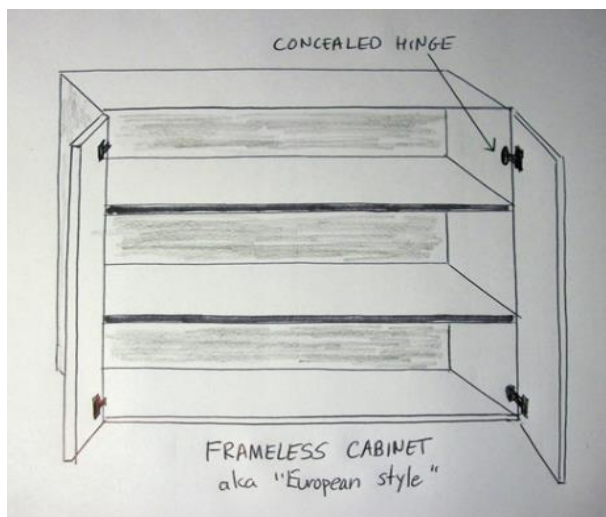

Arts Education / Applied Design, Skills, & Technology

HOME ECONOMICS

Why should you take a Food Studies or Child Development course?

- It will help you prepare for secondary work experience and apprenticeship programs.
- It will help you prepare for food, social science & health related careers.
- It will give you practical skills to help you live a healthy and enjoyable life.
- It will help you with college and university courses, such as Cook's Training, Human Ecology, Dietetics, Nutrition, Nursing, Medicine, Early Childhood Education, Social Work and Design.
- You may earn certificates that can be used for a part-time job while attending school.

Child Development and Caregiving 12 (MCDAC12) YouTube Link: <https://youtu.be/ZbXEe3woAlw>

Prerequisite: None

This four-credit course provides invaluable information on topics surrounding pregnancy and childbirth. It will also provide details on child development from birth to age 12, as well as how to care for babies and children in each stage of development. Other topics include getting ready for a baby, family dynamics, childcare options, and safety, as well as parental rights and responsibilities. This is an excellent course for those considering careers involving children, including healthcare, teaching, childcare, and recreation. It is also a good course for those who want to understand more about their own development, or who plan to eventually become a parent in the future. This Grade 12 course is also open to Grade 10 and 11 students who are interested in this topic. This is a participatory course, whereby assessment includes individual work, partner work, assignments, place-based learning, and project-based learning.

Food Studies 11 (MFOOD11)

YouTube Link: <https://youtu.be/xZcNkK1UjKE>

Prerequisite: None

Food Studies 11 is an entry level course in which students will be challenged with preparation techniques and theory. This course will be both fun and hard work. If you enjoy eating, being creative, working with your hands and want a relevant, practical, and career-oriented course, this is the one for you! Opportunities to assist in catering group functions and obtain Food Safe Level 1 Certificate may be provided outside of regular class time.

Food Studies 12 (MFOOD12)

YouTube Link: <https://youtu.be/xZcNkK1UjKE>

Prerequisite: MFOOD11 Recommended 60%

This is an advanced Food Studies course designed for hard working students with a love of food preparation. The course includes advanced techniques, new technologies, development of criteria for product and self assessment, development of original recipes, employing aesthetics, versatility, creativity, and quality in food preparation, working with nutrition challenges and the practical application of preparing food for large and small groups. Students considering a work experience in Food Studies should aim to complete Food Studies 12 by semester 1 of their Grade 12 year.

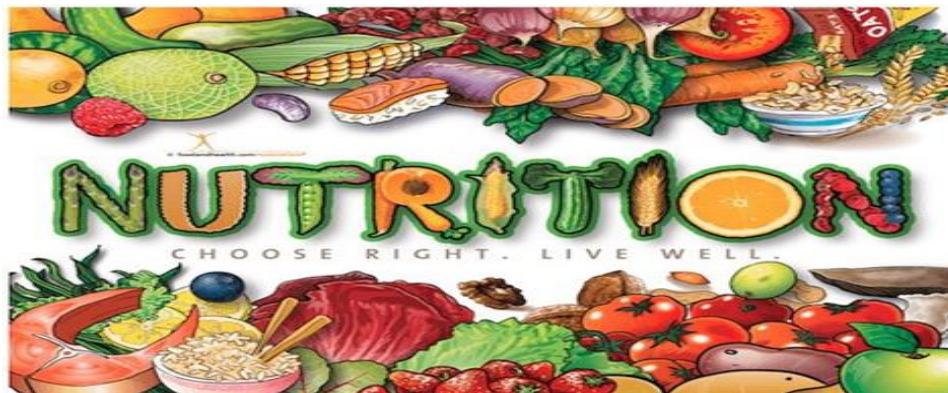

Arts Education / Applied Design, Skills, & Technology

BUSINESS EDUCATION

The aim of Business Education is to equip students with skills that will enable them to be successful in the business community. These courses teach practical lifelong skills needed by every student. Students interested in pursuing post-secondary education in Commerce or Business Administration are encouraged to take some of the course offerings in this department.

Accounting 11 (MAC11)

YouTube Link: <https://youtu.be/-Tkxaeq8Yyk>

Prerequisite: None

The Accounting course provides students with practical and valuable skills needed for lifelong financial decision making. The double-entry system and completion of the accounting cycle are integrated with use of the Excel spreadsheet computer program. Upon completion of the course, students can close out books & prepare balance sheets & income statements. A unit on income tax preparation is also covered through the CCRA Teaching Taxes program. Students will acquire practical and transferrable skills.

Accounting 12 (MACC12)

YouTube Link: <https://youtu.be/-Tkxaeq8Yyk>

Prerequisite: MAC11

Payroll, merchandise inventories, taxes, banking, and accounting procedures will be covered in Accounting 12. A major goal will be to enable the student to function successfully in an industry-standard computer environment. Practical experience using Sage computer software for everyday finances and small business applications will be part of the course.

Business Computer Applications 12 (MBCA12)

Prerequisite: None

Students are introduced to key computer applications tools that directly relate to the business world and will be useful going forward for the students, in both their educational and employment futures. Students will spend time learning and exploring Microsoft Word, Excel, and PowerPoint. Time will also be spent working with different programs available for creating a personal and business blog, building a simple website, and creating useful and professional Adobe PDF files. This class will be blended with Entrepreneurship 12, and therefore most elements will be taught with a focus on using the programs to create documents with a business focus.

Entrepreneurship 12 (MENT12)

Prerequisite: Must be in Grade 11 or 12

Students are introduced to the world of entrepreneurship, learning about the challenges and rewards of being a small business owner. Students will study the personal characteristics of successful entrepreneurs, the elements of a viable business, and the necessary steps in making a business plan. Students will develop the soft skills necessary to succeed in the business world, by participating in team-based projects and by developing and operating an actual business during the term.

Marketing & Promotion 11 (MMAP11)

YouTube Link: <https://youtu.be/OXhKYdliYTw>

Prerequisite: Must be in Grade 11 or 12

Students will be introduced to the “Design Thinking Process” and learn about the power of marketing and what makes, or breaks, a successful or unsuccessful marketing campaign. Time in class will be spent looking at examples of past and present marketing campaigns across the different marketing mediums of online, TV, radio, and print. Students will learn about the importance of the 3 P’s or Marketing: Price, Promotion and Placement. Students will learn about the ethics of marketing, what goes into creating a successful marketing campaign, how the current world and environmental forces factor into marketing, and the power of colour psychology in marketing. This class is a useful class for students looking at continuing with Business Education studies in post secondary or interested in understanding more about the advertising and marketing they see day to day in their lives.

Languages

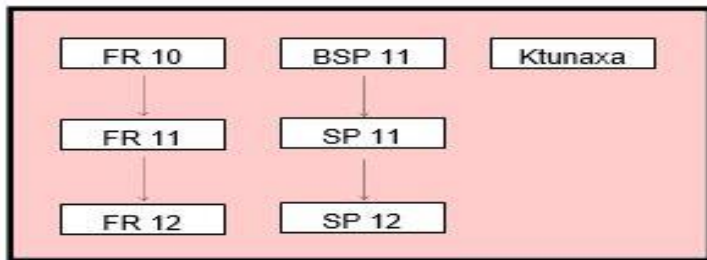

Core French 11 (MFR11) **Prerequisite: MFR10**

YouTube Link: <https://youtu.be/AJKiLQ8VZJU>

Structures and tasks in this course are much more sophisticated than those covered in French 10. French is the language of communication in the classroom, and it is expected that students demonstrate their ability to understand spoken French and communicate in French at a level consistent with the structures being presented. This course will include a variety of supplementary materials to help improve all skill areas.

Core French 12 (MFR12) **Prerequisite: MFR11**

YouTube Link: <https://youtu.be/AJKiLQ8VZJU>

French 12 completes the sequence of French courses offered at MBSS. Emphasis is placed on expanding oral and written comprehension as well as refining oral and written communication skills. French is the language of communication in the classroom.

Spanish Introductory 11 (MBSP11) **Prerequisite: None**

YouTube Link: <https://youtu.be/6Zfyhzld2iA>

This class is not for quiet students. Beginner Spanish is a fun way to learn to speak, read, and write Spanish. Much of your time is spent in oral communication and speaking practice. Students will learn pronunciation of Spanish sounds, a basic Spanish vocabulary, present tense verb structure, how to ask and answer questions, and most importantly this course will prepare students to communicate when they travel to a Spanish speaking country. Students will be required to complete daily homework online using the app Duolingo. Students who practice daily will be able to have a short but fluent conversation in Spanish with confidence by the end of the course.

Spanish 11 (MSP11) **Prerequisite: MBSP11**

YouTube Link: <https://youtu.be/6Zfyhzld2iA>

Students will continue to develop their language skills from Beginner Spanish in this course. Students will learn a variety of Spanish tenses as they further develop their speaking, reading, and writing skills. There is greater emphasis on read and speaking in this course while students will also be developing writing skills. Students are expected to work independently and to contribute to group projects throughout this course. By the end of the semester, students will be proficient at writing according to their own interests.

Spanish 12 (MSP12) **Prerequisite: MSP11**

Spanish 12 completes the sequence of Spanish courses offered at Mount Baker. Students in this course will continue to work towards fluency. There is a focus on the development of the mastery of grammar, verb tenses and sentence construction. Once again, the focus of this course is on speaking Spanish, but a significant amount of time will be spent reading and writing as well.

Ktunaxa Language **Prerequisite: None**

Aboriginal Education programs provide support for Ktunaxa Language in partnership with College of the Rockies. These courses are dual credit courses. Elders provide support for Ktunaxa Language 101/102.

Outdoor Education Programs

Outdoor Ed Program 11: Outdoor Education 11 (MODED11) & CLC 12 (MCLC12)

Prerequisite: CLE 10

This program (8 credits) combines Outdoor Skills 11 and Career Life Connections (CLC). Throughout this program we will learn hard skills such as navigation, avalanche terrain assessment and rescue skills, winter travel, backcountry camping, climbing indoors and out, environmental restoration, wilderness first aid, solo camping, mountain biking, ethnobotany, and canoeing. You will also learn soft skills such as communication, teamwork, and leadership. This course will help you learn about yourself and develop workplace skills through field-based learning and through mentorship opportunities in outdoor workplaces. No experience or specialized equipment needed (the school has backpacks, skis, snowshoes, tents, sleeping bags and mats available). Students must be willing to learn, challenge themselves, be outside and work as a team. A good work ethic and attendance record mandatory.

If you are interested in this course, please pick up an application in the counselling office and submit to Ms. Leigh Cormier. There is a fee for this course.

Outdoor Ed Program 12: Outdoor Ed 12 (MODED12) & Physical Geography 12 (MPGEO 12)

Prerequisite: a good attendance record, SS10 and some outdoor experience

This is an advanced outdoor education program in which students further develop outdoor and leadership skills while completing the academic outcomes of Physical Geography 12. This course is well suited for students passionate about the outdoors and exploration and who may be interested in pursuing a career with a field component, such as adventure or eco-tourism, teaching, forestry, parks, conservation, research, or resource management. Example topics and trips: Bugaboo Glacier and Tanglefoot Lake area to explore topics in geology, glaciology, and resource management, climb indoors, learn to canoe, overnight canoe trip, environmental education, and restoration, learn about local and global freshwater issues, Winter travel and survival, avalanche safety skills and meteorology, multi-day cross country ski trip, and expedition planning.

If you are interested in this course, please pick up an application in the counselling office and submit to Ms. Leigh Cormier. There is a fee for this course.

YouTube Link: https://youtu.be/UwgF5Fn_xrs

Contact leigh.cormier@sd5.bc.ca for more information about these courses.



Apprenticeship – Dual Credit

TRN (TRNE-2A) Train: Train in Trades

(Seats in Programs are limited. Applications are required and available from school counsellor.)

YouTube Link: <https://youtu.be/jv0RZWv7aQE>

Train in Trades is a dual-credit program that combines Foundation or Level I technical training in an apprentice-able trade with completion of the Grade 12 graduation plan. A student completes all required courses for graduation prior to entry in TRN and then becomes a full-time student at the College of the Rockies during their Grade 12 year. Additional grade 12 credits are earned at the same time as the student gets Skills Training in BC (skilledtradesbc.ca) credit for Year 1 technical training of apprenticeship. The goal is to complete workplace-based training hours subsequently with a sponsor employer to complete all Year 1 requirements for the trade.

The following eight trades are currently available as part of a partnership agreement with the College of the Rockies and STBC (Skilled Trades BC):

-Auto Service Technician	-Heavy Equipment Technician	-Hairstylist	-Cook
-Carpenter	-Industrial Mechanic	-Welder	-Electrician

The successful student attends the training program full time at the College of the Rockies Cranbrook campus for 24 to 44 weeks, depending on the trade. Credits are accrued at the school and with the STBC. Tuition costs are partly covered by the school district and the STBC.

Due to the start date of some TRN programs, it should be noted that students may be enrolled and expected to complete course requirements simultaneously. In cases like this, the student should communicate with the teachers at both institutions that they have dual responsibilities, and that consideration should be made for the completion of outstanding work/projects/tests that are required by either institution.

More information on this program is at <http://youth.itabc.ca/programs/train/>

The training schedule can be seen at <https://cotr.bc.ca/trades-training-schedule/>

For more details about applying, talk with your school counsellor or contact Tristan Taylor, Regional Transitions Coordinator. Phone: 250-489-2751 ext. 3380 or email taylor@cotr.bc.ca

WRK (MWRK-2A) Youth Work in Trades

The Youth Work in Trades Program is an excellent opportunity for motivated students who intend to have careers in one of British Columbia's approximately 120 apprentice-able trades. During Grades 11 and 12, the student will alternate regular in-school classes with approved paid work experience. Upon completion, the student receives both regular secondary graduation credits and credit with the Skilled Trades BC (STBC) towards first-year workplace-based apprenticeship training.

To enter this program, a formal application, including an interview and recommendations, is required. Application forms can be obtained from the Mount Baker Counselling Office. A student does not formally register in Youth Work in Trades until he/she has found an employer who will sponsor and register the student as an apprentice.

BENEFITS OF THE YOUTH WORK IN TRADES PROGRAM

- ◆ Access to the apprenticeship system while still in school, Opportunity for early start on a career
- ◆ Links to the world of work
- ◆ Practical application of school curriculum
- ◆ Incentive for high academic achievement
- ◆ Development of appropriate attitudes and responsibility
- ◆ Dual credit for work experience
- ◆ Uninterrupted transition from school to work
- ◆ Eligibility for a \$1000 scholarship

Dual Credit with College of the Rockies

Dual credit is an opportunity for high schools to provide students with course choices that are not otherwise available at the high school and accelerate a student's career pathway. Dual credit courses give students high school credit as well as post-secondary credit towards a credential in the BC public post-secondary system and elsewhere.

- 1. What college courses can a student take for dual credit?** As long as the students have met the prerequisites, they can take any post-secondary course that leads to a certificate, diploma, or degree as a dual credit course. College courses in Arts, Science, Kinesiology, Tourism and Recreation Management and Business would qualify, as would trades programs such as TRN (Train: Train In Trades).
- 2. Must students meet course prerequisites to take a college course?** Yes, unless permission is given by instructor.
- 3. How many credits does the high school award?** The high school awards 4 credits for a typical 3 credit college course (see Handbook of Procedures for the Graduation Program).
- 4. Do the College and high school agree on who takes dual credit courses?** When the student seeks a course at the College, the College gives the student a permission form to be signed by the school principal allowing the student to take the dual credit course.
- 5. Are dual credit courses taught in high schools?** The College can deliver the course either at a high school or at the College with a qualified instructor. Dual credit courses are also available online.
- 6. Where can I get more information about taking a dual credit course?** Tristan Taylor, Regional Transitions Coordinator, ttaylor@cotr.bc.ca, College of the Rockies Education Advisors, studentservices@cotr.bc.ca, your high school counsellors, or by visiting <https://cotr.bc.ca/enrolment-services/dual-credit/academic-dual-credit/>.
- 7. What are the costs?** With the school Principal's approval of the course, SD5 will pay the cost of tuition (unless the course is offered at MBSS, ex. Math 090). There are bursaries available to help with textbook costs upon application through Financial Aid at the College of the Rockies.

TRADES SAMPLER PROGRAM 12 (TSTE-2A/2B)

This project-based trades program is aimed at school-aged youth and will be delivered in collaboration with the College of the Rockies. The main objectives of this program are to provide students an opportunity to explore the basic components of a variety of trades and to help students to determine a trade suited to meet their personal goals. At the completion of the Trades Sampler Program, each student will be interviewed as to their interest and plans in pursuing a career in Trades. The program will include a variety of trades, workforce certificates, industry engagement with at least one guest speaker and/or workplace visit, visits to the College of the Rockies trades area and information on apprenticeship and trades careers.

Trades offered as part of the Trades Sampler Program include:

-Welding	-Piping Trades	-Auto Service Technician	-Heavy Mechanical
-Computer Assisted Drafting	-Carpentry	-Industrial Mechanic (Millwright)	-Electrical

The following industry related certificates will be included in the program content:

-WHMIS	-Occupational First Aid Level 1
-Fall Protection and Ladder Safety	-Construction Safety Training Systems (CSTS 09)

8 Grade 12 credits will be awarded for the successful completion of this program.

Dual Credit with College of the Rockies

CHILD AND YOUTH FAMILY STUDIES – DUAL CREDIT SEMESTER – BEGINS FEBRUARY 2025

Prerequisite: Minimum 65% in ENG 12

If you are a high school student in School District 5, 6, or 8, and would like to get a jump-start on a career as an Early Childhood Education, Education Assistant, or Human Service Worker this dual credit semester may be right for you. Daycares and School Districts in our region need more qualified staff to meet critical shortages.

WHAT YOU WILL GAIN:

- 16 high school credits toward graduation
- An educational qualification for work in an entry level position as an Early Childhood Education Assistant
- 13 post-secondary credits, of which 10 are credits in one of the CYFS certificate programs

Successful participants of the program will be immediately qualified to work as ECE Assistants and may choose to pursue a career as an Education Assistant.

Once working, students can build onto the 13 credits in the Child, Youth and Family Studies academic stream to specialize and pursue full certification in:

- Early Childhood Education – <https://cotr.bc.ca/programs/early-childhood-education/>
- Education Assistant - <https://cotr.bc.ca/programs/education-assistant/>
- Human Service Worker - <https://cotr.bc.ca/programs/human-service-worker/>

This 16-week semester includes three of the Child Youth and Family Studies core courses and an elective course to help you succeed in future post-secondary studies:

- CYFS 101 – Inclusive Interpersonal Communications
- CYFS 102 – Observing and Recording
- CYFS 116 - Lifespan Development
- HLTH 104 - Introduction to Personal Health and Wellbeing

For more information, talk to your school counsellor or phone the counselling office at 250-426-5241, ext. 25008 or contact Tristan Taylor at ttaylor@cotr.bc.ca or 250-489-2751, ext. 3380.



**COLLEGE OF
THE ROCKIES**

Leadership

ENVIRONMENTAL LEADERSHIP

Prerequisite: None

The Environmental Leadership Program is an active, participatory program that encourages Grade 10, 11, and 12 students to recognize their own capacity to effect positive change in their world to specifically address climate change, climate justice and environmental racism. Being aware of community-based issues related to climate change and climate justice, students will participate in school or local or global projects and initiatives (individually and in groups) that develop effective communication (oral and written), organizational skills, and decision-making related to climate justice. By learning from each other and people in their community, students will engage in topics, issues, and ideas that matter to them. This course is offered outside of the timetable for the entire year. In addition, students will be required to participate in planting and growing the school garden.

Students will be required to attend 25 hours of in class instruction. After that students will meet with the instructor at a mutually agreed upon time (morning, lunch, or after school). On-going reflections and evidence of personal growth (written and action-based) are required to receive credit for this course.

STUDENT LEADERSHIP (YCPA)

Leadership YouTube Link: <https://youtu.be/Bk5L88TdH70>

Prerequisite: None

The Student Leadership Program is an active, participatory program that encourages Grade 10, 11, and 12 students to recognize their own capacity to effect positive change in their world. Being aware of community-based issues and social justice concerns, students will participate in school or local or global projects and initiatives (individually and in groups) that develop effective communication (oral and written), organizational skills, and decision-making. By learning from each other and people in their community, students will engage in topics, issues, and ideas that matter to them.

This course is offered outside of the timetable. Students will meet with the instructor at a mutually agreed upon time (morning, lunch, or after school). On-going reflections and evidence of personal growth (written and action-based) are required to receive credit for this course.

LEADERSHIP—WARRIORS (YCPA)

Warriors YouTube Link: <https://youtu.be/4BRrUVf2Bxl>

Prerequisite: None

Warriors is an Indigenous Student Leadership Program. The Warriors create opportunities for Indigenous students to gain personal growth through **Service, Leadership, Teamwork and Culture**.

This course is offered outside the timetable. Students meet twice per month during lunch hour to focus on topics such as:

- ◆ Cultural activities such as building a tipi, drumming, trapping, Metis jigging, beading, storytelling, moccasin making, attending a Pow Wow or Metis Kitchen Party
- ◆ Effective communication and Organizational skills
- ◆ Consensus decision making processes
- ◆ Personal growth plans and
- ◆ School wide initiatives and Community based initiatives
- ◆ Human dignity
- ◆ Anti-racism
- ◆ Meeting Protocols
- ◆ Team building

This course is open to all Indigenous students in Grades 10, 11, & 12. This is a four-credit program. Regular attendance, participation in events and evidence of personal growth (both written and action based) are required to receive credit for this course. A total of 100 hours must be completed to receive credit.

Work Experience 12

Work Experience offers an opportunity for students to practice school-based learning in a working environment. It opens doors to employment and to post-secondary education.

Work Experience 12A & 12B provide students with on-the-job work experience. These are four-credit courses. Students should connect Work Experience with a career goal and their Career Life Connections plan. Some post-secondary programs now require work experience for admission.

Work Experience bridges the gap between school and the workplace by integrating courses in a meaningful way to help students broaden their education and define their career objectives.

Work Experience enhances student achievement by:

- Providing on the job training
- Easing the transition from school to workplace
- Developing competencies in problem solving skills related to a specialized area of study
- Strengthening feelings of pride and self-confidence in work well done
- Increasing personal and social skills in co-operative work situations
- Providing contact with people in the community, references from such people, and possible future employment opportunities

Indigenous Education

Indigenous Education is for everyone. It is based on providing holistic supports: academic, physical, emotional, and spiritual. The broad goals of Indigenous Education are to support all First Nations (on and off reserve), Metis, and Inuit students and to infuse Indigenous perspectives across the curriculum.

Indigenous Education Support Workers (IESW) and Elders assist Indigenous students and their families in navigating the school system. They reinforce pride and identity amongst Indigenous students. The IESW and Elders are available to help all MBSS students, staff, and teachers.

Example of Services and Supports for students:

Help with schoolwork

Help with post-secondary planning

Tutoring and Mentoring

Personal and cultural support

Snacks, drinks, and lunches available

Advocate

Where: Gathering Place, Room 101 8:00 AM – 3:30 PM

Contact Information: 250-426-5241, ext. 25052 and 25101



Counselling

Counsellors at Mount Baker Secondary School assist students with a wide variety of personal, educational, and career-related concerns. Some examples of services:

PERSONAL COUNSELLING - assists students who are experiencing personal difficulties which interfere with their academic, social and/or family life.

EDUCATIONAL COUNSELLING - provides help in choosing appropriate courses and making educational plans for graduation.

INFORMATION AND REFERRAL SERVICES – Current selection of university and college calendars, scholarships and bursaries, and referrals to liaisons with social agencies, educational institutions, government agencies, and the business community.

It is our hope that through the resources available in the Counselling Department, students will be better informed and able to make appropriate decisions for themselves now and in the future. Counsellors can be accessed in non-emergency situations by making an appointment online on the Mount Baker website, under Students > Counselling Appointments, or with the secretary at 250-426-5241, ext. 25008.

Earning Credits Toward Graduation

You'll probably earn most of your credits toward graduation the usual way – by successfully completing school-based courses. But there are other ways of earning credits, and some of these might work for you.

Read through the list of options below. For more information, talk to your school counsellor or go to: www.bced.gov.bc.ca/policy/policies

Distributed Learning
Equivalency
External Credentials

Advanced Placement
Course Challenge
Youth Work in Trades

Post-Secondary Courses
Train: Train in Trades
Independent Directed Studies

Independent Directed Studies (IDS 10/11/12):

The purpose of this course is to permit students to initiate their own course of learning at the Grade 10, 11, or 12 level under the supervision of a teacher. **IDS 10/11/12 will only be available through consultation with a counsellor and permission of the appropriate department head. 1 to 4 credits may be earned. This is completed outside the timetable.**

Student Services

Located in Rooms 125 & 126, the MBSS Student Services Team provides a variety of support services for students. Our goal is to provide students with appropriate levels of support and meaningful programs to enhance learning in the school or in the community. Based on the specific academic, social, emotional, and physical needs of the individual student, some of these services include:

- Quizzes and tests (separate setting, oral questions, scribing)
- Adaptations (curriculum, test, homework, setting)
- Support with the acquisition of functional life skills
- Development of an Individualized Education Plan (IEP)
- Modification of academic core courses (Math, Social Studies, Science, English) for students working towards a BC School Completion Certificate (Evergreen Certificate)
- Meetings with students and parents to review progress and plan for future goals
- Arrangement of work experience where appropriate and possible

Checklist and Information

IF YOU ARE ENTERING GRADE 10:

- You have selected:
An EN 10 option, SS10, WPM or FMP 10, SC 10, PHED 10, and Career Life Education 10
- You will need to select some electives to complete your Course Selection to make a total of **NO LESS THAN 8 COURSES** in the timetable

Additional courses may be taken outside the timetable.

IF YOU ARE ENTERING GRADE 11:

- You have selected:
an EN 11 option, a SS 11 or 12, a SC 11 or 12, a MA 11 or 12, a course or courses that give you credit for the **Arts Education / Applied Design, Skills and Technology** graduation requirement
(Note: this may have been met in Grade 10 elective choices)
- You have selected courses that lead you to the Grade 12 courses you will want next year (Prerequisites)
- You have selected no less than 8 courses

Additional courses may be taken outside of the timetable.

IF YOU ARE ENTERING GRADE 12:

- You have selected or already passed:
English Studies 12 or English First Peoples 12, plus at least 3 other Grade 12 courses
- You have selected or already passed an Indigenous-focused course in Grade 10 or 11
- You have **no less than 32 credits from SD5** to be eligible for internal scholarships
- You have checked the graduation requirement to see that you meet all of them.
80 credits are necessary for graduation. Career Life Connections must be completed for graduation
- Your Course Selection meets the necessary prerequisites of the post-secondary institutions and programs you may be considering after Mount Baker Secondary

Finally – check with a counsellor if you are in doubt about any of the above. Wise Course Selection to prepare for your future is **YOUR RESPONSIBILITY.**